

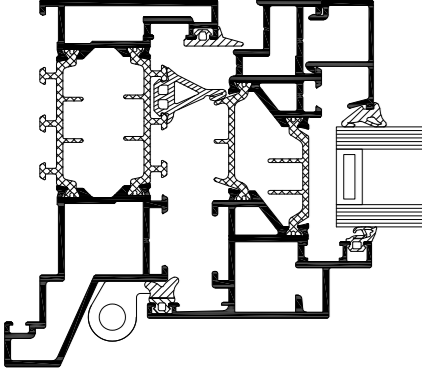





# SLIMLINE 38 CUBIC WINDOWS - OUTWARD OPENING

|  |  |
|--|--|
| <p>SL 38 CUBIC GETEKEND<br/>SL 38 CUBIC DESSINE<br/>SL 38 CUBIC DRAWN<br/>SL 38 CUBIC GEZEICHENET</p>  | <p>ISOLATIE VARIANT SL 38 CUBIC<br/>ISOLATION VARIANTE SL 38 CUBIC<br/>INSULATION VARIANT SL 38 CUBIC<br/>ISOLATION VARIANTE SL 38 CUBIC</p> <p>SL 38 STANDARD      SL 38-HI</p>  |
|--|--|

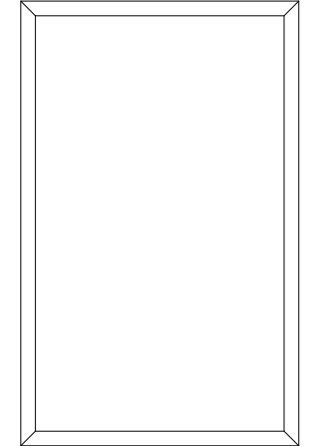
OVERZICHT OPENINGS TYPES  
APERÇU TYPES D'OUVERTURE  
OVERVIEW OPENING TYPES  
ÜBERSICHT ÖFFNUNGSARTEN

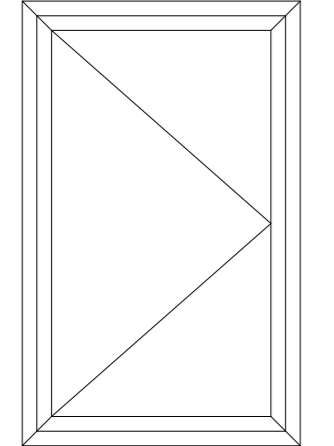
|   |  |
|---|--|
| <p>VAST RAAM<br/>FENETRE FIXE<br/>FIXED WINDOW<br/>FESTVERGLASUNG</p>  <p> 1a</p> | <p>OPENGAAND RAAM<br/>FENETRE OUVRANT<br/>OPENING WINDOW<br/>AUFGEHENDES FENSTER</p>  <p> 2a</p> |
|---|--|

|  |  |  |
|--|--|--|
| <p>PROFIELOVERZICHT<br/>APERÇU DES PROFILES<br/>PROFILE OVERVIEW<br/>PROFILUEBERSICHT</p> <p> </p> | <p>HULPPROFIELEN<br/>PROFILES DE RACCORDEMENT<br/>ADDITIONAL PROFILES<br/>ZUSATZPROFILE</p> <p> <a href="#">SL 38 Window_Additional profiles.dwg</a></p> | <p>BOUWAANSLUITINGEN<br/>RACCORDEMENTS AU BATIMENT<br/>BUILDING CONNECTIONS<br/>BAUANSCHLUESSE</p> <p> <a href="#">... .dwg</a></p> |
|--|--|--|

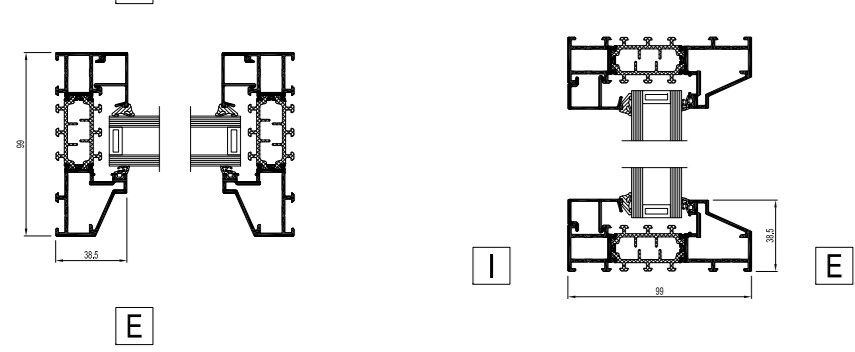
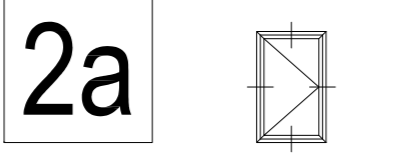
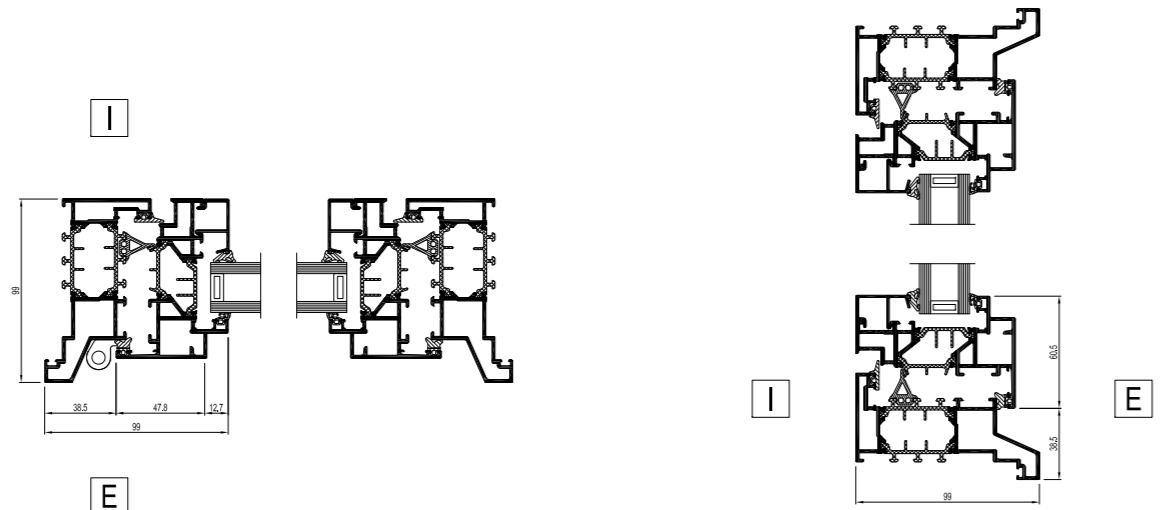
|   |   |
|---|---|
| <p>1a</p>   | <p>2a</p>   |
|---|---|

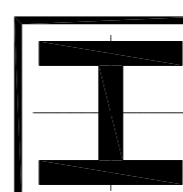
 PROFIELOVERZICHT  
APERÇU DES PROFILES  
PROFILE OVERVIEW  
PROFILUEBERSICHT

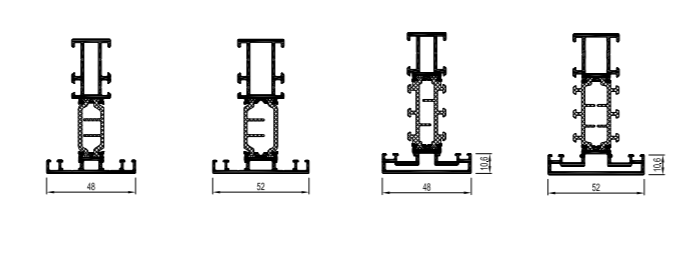
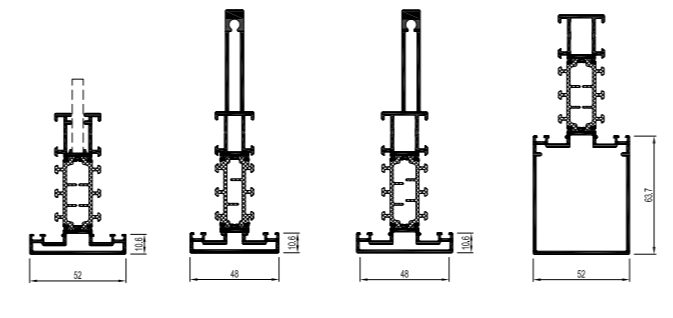
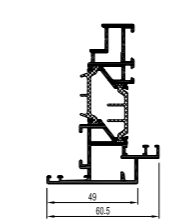
|   |  |
|---|--|
| <p>T-PROFIEL<br/>TRAVERSE<br/>TRANSOM-MULLION<br/>SPROSSE</p>  | <p>T-PROFIEL VERSTERKT<br/>TRAVERSE RENFORCEE<br/>TRANSOM-MULLION REINFORCED<br/>SPROSSE VERSTERKT</p>  |
| <p>VLEUGEL<br/>OUVRANT<br/>VENT<br/>FLEUGEL</p>                |  |

 DE PROFIELKEUZE WORDT BEPAALD DOOR DE MAXIMALE AFMETINGEN EN HET MAXIMALE GEWICHT VAN HET ELEMENT. NEEEM CONTACT OP MET UW REYNAERS ALUMINIUM FABRIKANT OM DE JUISTE PROFIELKEUZE TE BEVESTIGEN.

LE CHOIX DU PROFILÉ EST DÉFINI PAR LES DIMENSIONS MAXIMALES ET LE POIDS MAXIMUM DE L'ÉLÉMENT. VEUILLEZ CONTACTER VOTRE FABRICANT REYNAERS ALUMINIUM POUR CONFIRMER LE BON CHOIX DE PROFILÉ.

THE PROFILE SELECTION IS DEFINED BY THE MAXIMUM DIMENSIONS AND WEIGHT OF THE ELEMENT. PLEASE CONTACT YOUR REYNAERS ALUMINIUM FABRICATOR TO CONFIRM THE RIGHT PROFILE SELECTION.

DIE PROFILAUSWAHL WIRD DURCH DIE MAXIMALEN ABMESSUNGEN UND DAS GEWICHT DES ELEMENTS DEFINIERT. BITTE WENDEN SIE SICH AN IHREN REYNAERS ALUMINIUM HERSTELLER UM DEN RICHTIGEN PROFILAUSWAHL ZU BESTÄTIGEN.